

**RF & MICROWAVE TRANSISTORS**  
**450-512MHz CLASS C MOBILE APPLICATIONS**

- CLASS C TRANSISTOR
- FREQUENCY 470MHz
- VOLTAGE 12.5V
- POWER OUT 0.6W
- POWER GAIN 13.0dB
- COMMON EMITTER

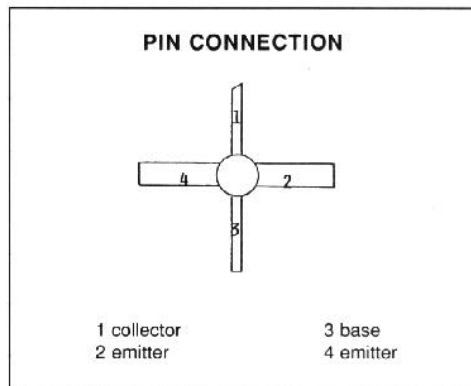

**DESCRIPTION**

The SD1132-5 is a 12.5V epitaxial silicon NPN planar transistor designed primarily for UHF predriver applications. This device uses nichrome aluminium metallization to achieve infinite VSWR at rated operating conditions.

**ABSOLUTE MAXIMUM RATINGS** ( $T_{case} = 25^{\circ}C$ )

Symbol	Parameter	Value	Unit
$V_{CBO}$	Collector - Base Voltage	36.0	V
$V_{CEO}$	Collector - Emitter Voltage	18.0	V
$V_{CES}$	Collector - Emitter Voltage	36.0	V
$V_{EBO}$	Emitter - Base Voltage	4.0	V
$I_C$	Collector Current	0.7	A
$P_{tot}$	Total Power Dissipation	2.5	W
$T_{stg}$	Storage Temperature	- 65 to + 150	$^{\circ}C$
$T_j$	Junction Temperature	+ 200	$^{\circ}C$

**THERMAL DATA**

$R_{th(j-c)}$	Junction-case Thermal Resistance	70.0	$^{\circ}C/W$
---------------	----------------------------------	------	---------------

**SD1132-5**

**ELECTRICAL CHARACTERISTICS** ( $T_{case} = 25^{\circ}C$ )

**STATIC**

Symbol	Test Conditions		Value			Unit
			Min.	Typ.	Max.	
$BV_{CES}$	$I_C = 10mA$	$V_{BE} = 0$	36.0			V
$BV_{CEO}$	$I_C = 10mA$	$I_B = 0$	18.0			V
$BV_{EBO}$	$I_E = 5mA$	$I_C = 0$	4.0			V
$I_{CBO}$	$V_{CB} = 12.5V$	$I_E = 0$			1.0	mA
$h_{FE}$	$V_{CE} = 5.0V$	$I_C = 150A$	20.0			

**DYNAMIC**

Symbol	Test Conditions		Value			Unit
			Min.	Typ.	Max.	
$P_O$	$f = 470MHz$	$V_{CE} = 12.5V$	0.6			W
$G_P$	$f = 470MHz$	$V_{CE} = 12.5V$	13.0			dB
$C_{OB}$	$f = 1MHz$	$V_{CB} = 12.5V$ $I_E = 0$			4.0	pF

**APPLICATION INFORMATION** (typical curves)

**POWER OUT vs POWER IN**

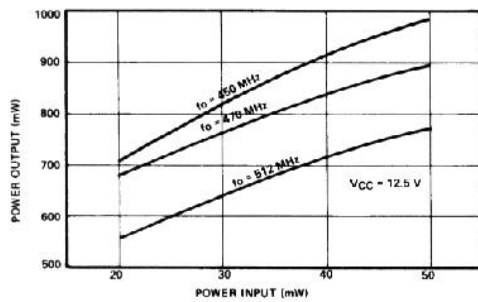

S88SD1132-5-02

**POWER OUT vs VCC**

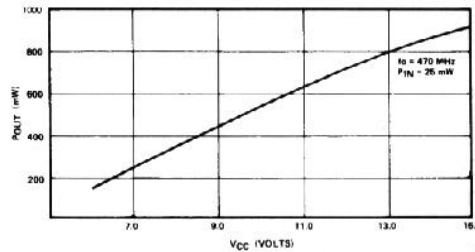

S88SD1132-5-03

**POWER OUT vs FREQUENCY**

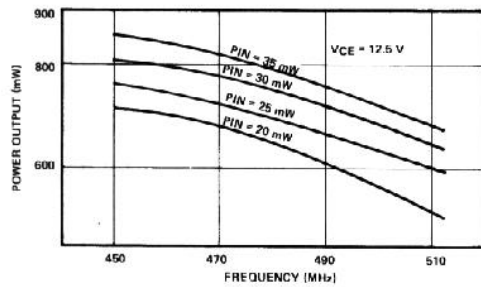

S88SD1132-5-04

**IMPEDANCE DATA** (typical)

$Z_s = 1.5 + j 0.5.5\Omega$   
 $Z_{CL} = 14 + j .43\Omega$

$F = 470\text{MHz}$   
 $V_{CE} = 12.5\text{V}$   
 $P_1 = 0.025\text{W}$

SOURCE IMPEDANCE vs FREQUENCY

COLLECTOR LOAD IMPEDANCE vs FREQUENCY

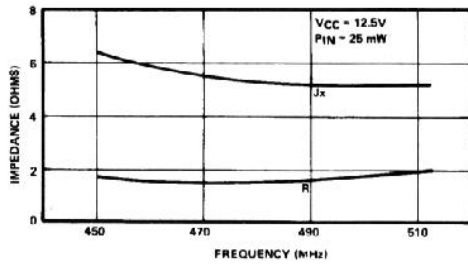

S88SD1132-5-05

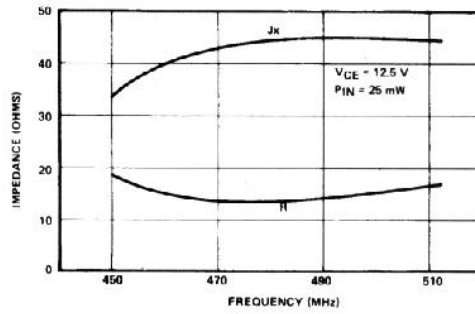

S88SD1132-5-06

SD1132-5

TEST CIRCUIT (450-512MHz)

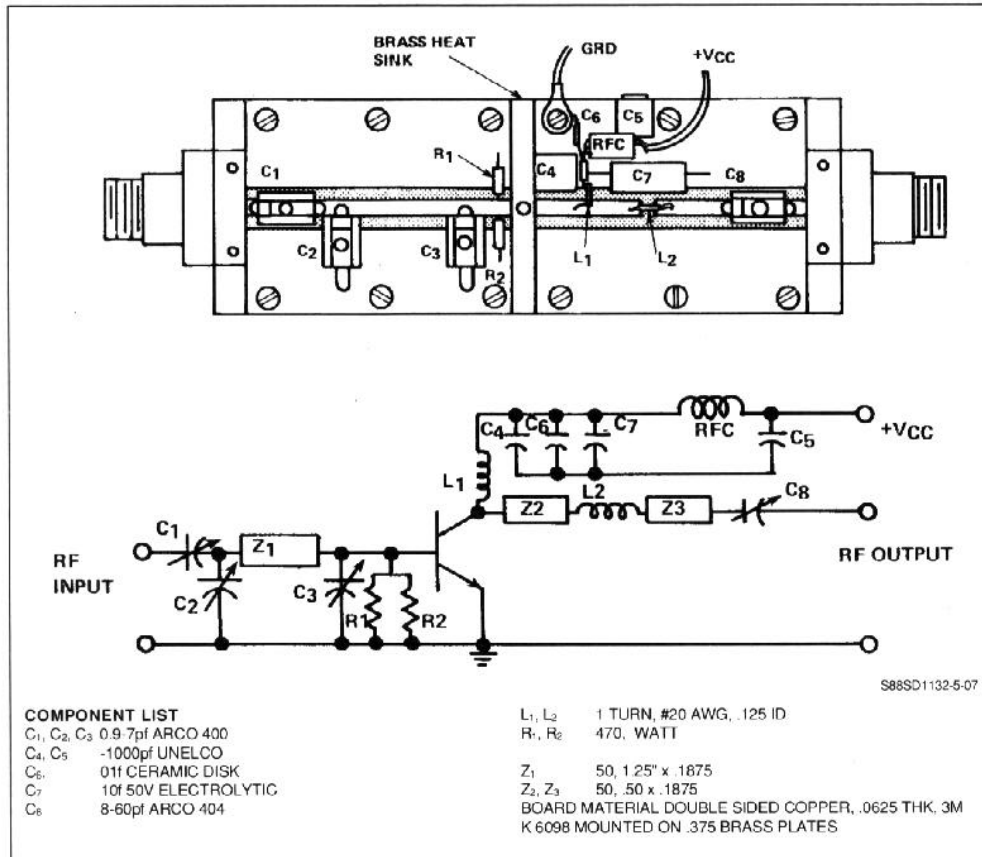

## PACKAGE MECHANICAL DATA

X072

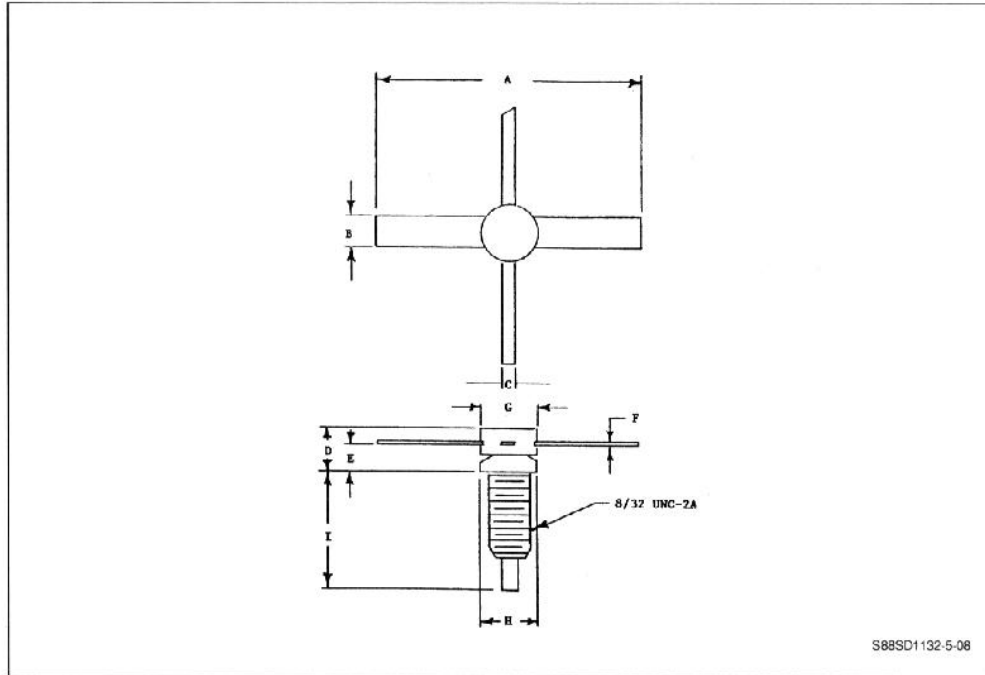

S88SD1132-5-08

	Minimum Inches	Maximum Inches
A	.890	
B	.120	.130
C	.027	.033
D		.195
E	.098	.112
F	.003	.007
G	.201	.207
H	.201	.207
I	.425	.465